

# A framework for the decentralised management of wastewater in Zimbabwe

Innocent Nhapi \*

*Department of Civil Engineering, University of Zimbabwe, Box MP167, Mt Pleasant, Harare, Zimbabwe*

---

## Abstract

The traditional wastewater management style is now presenting some problems, having evolved from a situation of small communities, little industrial activities, and abundance of freshwater. The style is characterized by high water consumption and large treatment plants that employ sophisticated treatment systems with final effluent discharged to rivers. This paper focuses on analysis and development of an alternative strategy of decentralised wastewater management in Zimbabwe. Serious pollution problems related to inappropriate effluent discharges are prevalent necessitating an efficient and reliable strategy of controlling environmental pollution whilst obtaining optimal benefits from wastewater reuse. A conceptual plan for the decentralised strategy was developed taking into account capital and operational costs, wastewater generation patterns and quality, and urban agriculture. Maize cultivation was used to illustrate the implications of water and nutrient utilisation potential of the strategy. It was concluded that the strategy would suit high and medium density dwellings in Zimbabwe and that greywater separation can be used as part of the strategy.

© 2004 Elsevier Ltd. All rights reserved.

*Keywords:* Decentralised; Greywater separation; Reuse; Urban agriculture; Wastewater management

---

## 1. Introduction

The current Urban Water Management (UWM) systems evolved from a situation of small populations consuming small amounts of water, the presence of only small-scale industrial activities and, thus, the release of few harmful substances into the environment, and the availability of large volumes of fresh water. Consequently, neither the water consumption nor the discharge of the wastes had significant impacts on the environment. When urban populations increased, and specifically, when nearby waste discharges resulted in unhealthy conditions and disease outbreaks, waste needed to be discharged further away from human hab-

itation. Therefore, waste transport came into existence using open drains and, later, pipes systems. For this transport to work, a certain water flow was needed to prevent the settling of waste components. The required water flow in the pipe system was significant and became a major parameter in the design of the first water-based toilets. With (1) water virtually free of charge, (2) almost no economic need or environmental incentive to limit water consumption, and (3) the concept that water improved hygiene, per capita urban water consumption rates have gradually risen to levels ranging from about 80l/day to as high as 625l/day (Metcalf and Eddy, 1991; JICA, 1996). However, per capita consumption figures in urban slums can be as low as 15l/day (Siebel and Gijzen, 2002).

The current approaches to urban wastewater management mainly focus on onsite and centralised solutions (Fig. 1). In developing countries, onsite systems

---

\* Tel.: +263 4 303288; fax: +263 4 303288/+263 91 338921.

E-mail address: [inhapi@eng.uz.ac.zw](mailto:inhapi@eng.uz.ac.zw)

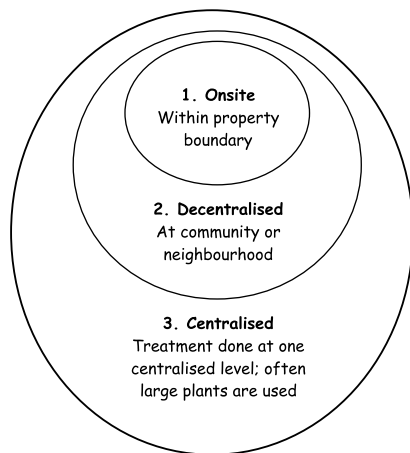

Fig. 1. Three levels of wastewater management.

are generally used for high income and low-density areas where the cost of collection infrastructure discourages sewered systems. Septic tanks, constructed wetlands, and infiltration systems are normally used. Low-income areas also employ onsite systems especially in peri-urban slums and areas served by communal toilets. Composting toilets, ordinary pit latrines, and urine separating toilets are mostly used. The sewage from most cities is treated using the conventional activated sludge systems, trickling filters and waste stabilisation ponds. The effluent and sludge are used for irrigation, mostly plantations and pastures. An intermediate system, the decentralised concept, is receiving increased attention because of perceived numerous advantages over the other two. This paper focuses on the development of this concept under the Zimbabwean conditions. The justification of this approach is presented, together with typical examples in Zimbabwe and lessons from literature.

## 2. Constrains of onsite and centralised systems

The greatest hindrance to onsite systems in Zimbabwe is space availability and the need to dispose of considerable quantities of sewage in high-density areas (Taylor and Mudege, 1997; Nhapi et al., 2002a). Although they offer opportunities for resource recovery and reuse, most of the common types of onsite systems are considered second-rate and a compromise to present comfort and convenience associated with sewered systems. Septic tanks have been successfully used in sparsely populated areas and where ground conditions are suitable (JICA, 1996). The current centralised systems are characterised by high water consumption, especially for transporting wastes out of cities (JICA, 1996; Nhapi et al., 2002b). Precious resources are diluted making resource recovery much more complicated, thereby threatening receiving waters. There is lack of control over

what is being discharged into wastewater resulting in heavy metal content in wastewater (Manjonjo, 1999). The mixing of industrial waste streams further complicates resource recovery and reuse than if process streams would be kept separate. With, generally, little awareness of environmental consequences, little institutional attention for recovery of resources, and with only degradable organics potentially removed from wastewater effluent or sludge, the remaining resources are either distributed into surface waters or into sludge. As such, wastewater collection and treatment contribute to environmental pollution.

With increasing centralisation of wastewater treatment facilities and continued growth of cities, even the effluent from well-performing facilities causes environmental risks. Most of the technologies used for centralised treatment of wastewater are expensive (investment and maintenance) and require well-trained staff. For these and other reasons, an intermediate or decentralised approach to wastewater management is urgently needed aiming at resource conservation and reducing environmental impacts of current approaches.

## 3. Advantages of decentralised wastewater systems

The concept of decentralised wastewater management aims at the development of wastewater systems that are more financially affordable, more socially responsible, and more environmentally benign than conventional centralised systems. The concept goes beyond merely managing individual systems, filling in the gap between onsite systems and the conventional centralised system. This approach allows wastewater management to be broken down to the neighbourhood level and to serve disaggregates of the larger urban areas, resulting in small-scale and low-cost facilities directly related to reuse of valuable components in the wastewater. Decentralised treatment systems should be as 'fail safe' as possible, i.e., should be stable due to biological diversity or have a physical configuration that ensures that mishaps or temporarily poor operating conditions would not routinely lead to bypasses of poorly treated water. Chosen technologies would suit site-specific conditions and financial resources of individual communities, and these would include septic tanks and waste stabilization ponds (WSP) in combination with constructed wetlands (CW) and duckweed-based pond systems (DPS).

Natural treatment systems suit developing countries because they have low energy requirements, and inexpensive construction/operating conditions. In addition, the systems seem to operate optimally under tropical conditions. Depending on local conditions, biogas from anaerobic pre-treatment can be collected for use. Reuse options include the use of effluents for crop and plantation irrigation, and harvesting of biomass for human or

animal feed (duckweed, aquaculture). The prevalence of urban agriculture in Zimbabwean urban towns (Bower-Bower et al., 1996) makes the reuse of sewage effluent for food production more attractive.

The decentralised concept promises a number of advantages over conventional practices in the development of new wastewater systems. The flows at any point would remain small, implying less environmental damage from any mishap. System construction would also result in less environmental disturbances as the smaller collection pipes would be installed at shallow depths and could be more flexibly routed. The system expansion would be afforded by adding new treatment centres rather than routing ever more flows to existing centres. Industrial waste would not be commingled with domestic wastes; as industrial wastewater generators could be legally compelled to implement treatment methods specific to their wastewater characteristics and reuse opportunities.

Financial advantages would result from the elimination of a great deal of the collection system infrastructure, the use of small diameter sewers, and the choice of technologies that incur minimal maintenance costs. The effluent would be available throughout the service area, nearer to points of potential reuse, decreasing the cost of reclaimed water distribution networks. Non-potable demands such as landscape irrigation and toilet flushing could be served with reclaimed water. It is easier to plan and finance, as each project is small compared to the typical conventional system expansion. The management needs of each new area or new development are considered directly and could be implemented independently. Different management strategies could be employed in various parts of the service area, responding in the most financially efficient and environmentally responsible manner to each set of circumstances.

However, decentralised treatment and reuse systems potentially pose health risks and possibly contaminate groundwater with heavy metals and nitrates. The implementation of cleaner production principles (Siebel and Gijzen, 2002; Nhapi and Hoko, 2002) could reduce this risk. Health risks could be reduced by disinfection (Asano and Levine, 1996), avoiding spray irrigation methods (aerosol effects) (Mara, 1996), boiling all food grown with sewage effluent (Cairncross and Feachem, 1983; Pescod, 1992). Adequate protective clothing and safe handling procedures for workers are also necessary (Khouri et al., 1994).

#### 4. Examples of decentralised systems in Zimbabwe

The decentralised concept of wastewater management as a deliberate strategy is fairly new (Venhuizen, 1998). However, there are a number of cases in Zimbabwe that can be easily modified to suit this criterion. Some examples are given below for the towns of Gweru, Redcliff, Mupandawana and Nemanwa.

##### 4.1. Gweru

Gweru City Council has been operating an innovative hybrid sewage treatment plant since 1994. The plant has a treatment capacity of 90,000PE (5625 m<sup>3</sup>/d) and consists of inlet works, primary and secondary anaerobic ponds, and a set of trickling filters (Fig. 2). The effluent is used for pasture irrigation while the sludge is used for gum plantation irrigation. No humus tanks were installed but the effluent still meets the standard limit of 70 mg/l BOD required for irrigation purposes (Broome et al., 2002). The council considers present performance as satisfactory although modifications could be required

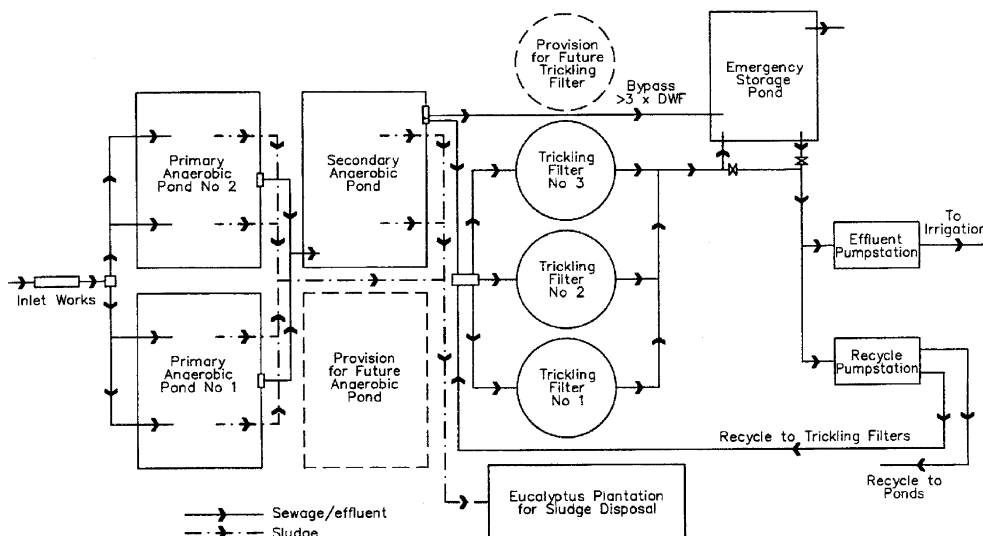

Fig. 2. Schematic layout of Cambridge sewage treatment works, Gweru (Source: Broome et al., 2002).

to meet new nitrogen regulations for effluent irrigation of <math>300\text{ kg/ha yr}</math> (S.I. 274 of 2000).

4.2. Redcliff

The development of small, decentralised sewage treatment plants is illustrated by the Redcliff scheme (Fig. 3). Six plants with capacities ranging from 500 to 2000 m<sup>3</sup>/d and serving a population of about 40,000 are distributed around the town. At some plants, effluent is used for golf course irrigation and sludge for gum plantation irrigation. However, the use of biological nutrient removal plants at Redcliff, Rutendo and ZISCO discourages the reuse thrust of the decentralised concept and makes treatment very costly. Treatment technologies like duckweed-based pond systems, constructed wetlands plus aquaculture could be used to enhance resource recovery.

4.3. Nemanwa

The use of duckweed-based pond systems (DPS) at Mupandawana and Nemanwa offers an opportunity

for the development of decentralised wastewater systems in Zimbabwe. Pilot studies on DPS in Zimbabwe were started in 1996 by the Institute of Water and Sanitation Development (IWSD). Work on two full-scale DPS started in June 1999 at Nemanwa and Mupandawana in the Masvingo Province. These towns have respective populations of about 5000 and 10,000. Existing waste stabilization ponds were used with a typical setup as shown in Fig. 4. The plant at Mupandawana serves only about 250 commercial and 270 residential stands, receiving about 400 m<sup>3</sup>/d of sewage. Bamboo floating booms sub-divided the ponds into 15 m by 20 m bays, helping in controlling wind effects. Duckweed was harvested from the sub-divisions and dried in sheds covered with a Hessian cloth to allow a limited amount of light to penetrate and a perforated, raised floor allowed the draining of water. Air drying in the shade took four days and sun drying on a black plastic sheet took 6 days. After drying, the duckweed was weighed and stored in 50 kg bags ready for use as chicken feed.

At Nemanwa the chicken project was run by a youth organisation whilst at Mupandawana the chicken project failed to take off due to socio-cultural attitudes to-

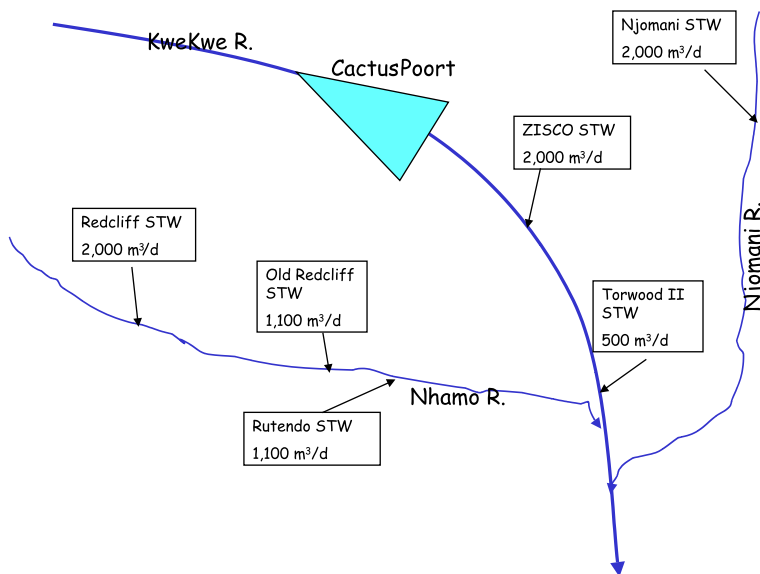

Fig. 3. Schematic layout of sewage treatment works in Redcliff.

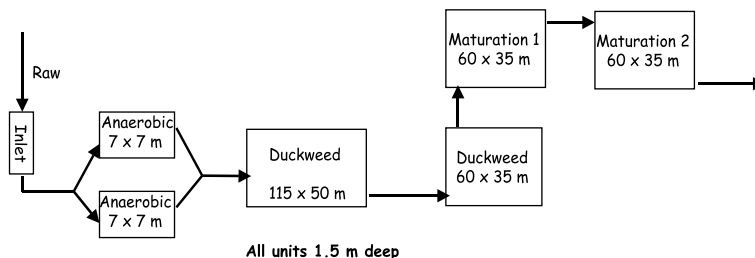

Fig. 4. Schematic illustration of a duckweed-based pond system at Nemanwa.

wards wastewater reuse. The chicks were fed on a conventional broiler starter marsh for the first 3 weeks after which they were put on a diet with varying proportions of duckweed (0%, 10% and 20% duckweed by weight). Tests at the University of Zimbabwe confirmed that duckweed can be incorporated in broiler ration up to 10% level without compromising growth performance or carcass composition (Kusina et al., 1999). Samples sent for broiler performance and microbiological analysis also confirmed that the chickens from both centers were suitable for human consumption (IWSD, 2000). At Nemanwa a vegetable gardening project was started in 2000 using chicken droppings and dried duckweed as manure. The economic viability of these plants needs to be fully assessed. The duckweed could be further fed to fish (FAO, 1999) and the effluent used for irrigation.

## 5. A conceptual plan for Zimbabwe

Most of the Zimbabwean towns have populations less than 100,000 and their sewage treatment plants rarely have capacities more than 10,000 m<sup>3</sup>/d. Most of these plants use activated sludge systems. Fig. 5 was derived from Nhapi et al. (2002b) and shows that investment costs for small conventional plants are very high on a per capita basis compared to larger treatment works. The average cost is USD36/cap while a waste stabilization plant constructed during the same period cost USD3/cap. A decentralised strategy should therefore include natural treatment systems for economic reasons.

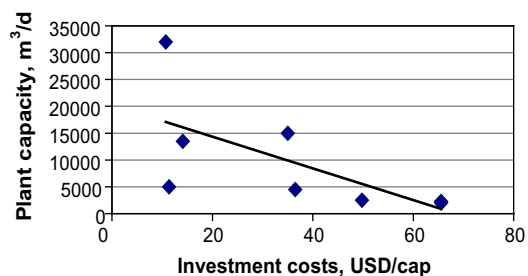

Fig. 5. Capital costs for conventional sewage treatment works constructed under the Urban II Program in Zimbabwe (Source: Nhapi et al., 2002b).

The formulation of a decentralised strategy in Zimbabwe is hindered by the unavailability of proven and reliable data for basic design. The current design parameters for water consumption and wastewater production needs updating and validation. The classification of residential areas (into high, medium, and low density) was changed by the responsible ministry in 1994. In this document, the traditional classification was used (Table 1) as it is more functional than the 1994 official classification that was introduced mainly for funding purposes.

The sources of urban household wastewater in Zimbabwe are shown in Fig. 6. The per capita wastewater production figures for medium and low-density areas are on the higher side compared to international figures of about 120 l/capd (Metcalf and Eddy, 1991). A combination of end-use efficiency, system efficiency, storm-water harvesting, storage innovations, and reuse strategies would greatly reduce these figures. The estimated proportion of water required for drinking and cooking is only 5–8%, whereas 25–38% is wasted in toilet flushing. The greywater portion is represented by kitchen, laundry, and bath water. The high water usage for bathing and toilet flushing could be explained by installed water systems in homes—large geysers, tubs, and cisterns. A great deal of reduction is feasible if water saving measures are employed.

A typical design strategy for a decentralised system is given in Fig. 7. Many considerations would determine how close to the source of generation it is practical to address treatment and disposal. One of these is if and how the wastewater could be reused in a beneficial manner. Other considerations include topography, soil conditions, development density, and type of land use. To minimise the operations and maintenance liabilities of this strategy requires technologies that are appropriate to the volume of flow, the nature of the development served, and the nature of the reuse opportunities. It should be possible to use combined or separated wastewater streams in this scheme. In Fig. 7, scheme, water conservation and pollution prevention/reduction measures are used to reduce outflows from individual stands. Reduced water consumption will result in concentrated wastewater. This scheme can accommodate both separated (greywater, urine) and combined wastewater flows.

Table 1

Water consumption and wastewater production in Zimbabwe (Marks, 1993 and Councils<sup>a</sup>)

Area	Stand area, m <sup>2</sup>	Household size, people per stand	Water use, l/stand/day	Wastewater production, l/stand/day	Wastewater charges, USD/month
High density	≤500	10	815	692	2.51
Medium density	500–1500	8	1500	1050	3.20
Low density	>1500	6	2500	1250	3.20

<sup>a</sup> N.B.: The tariff figures were obtained from Harare, Norton, Marondera and Redcliff and are fairly indicative of figures in all towns of Zimbabwe. Most of the towns use block tariffs for water and a fixed charge for sewerage.

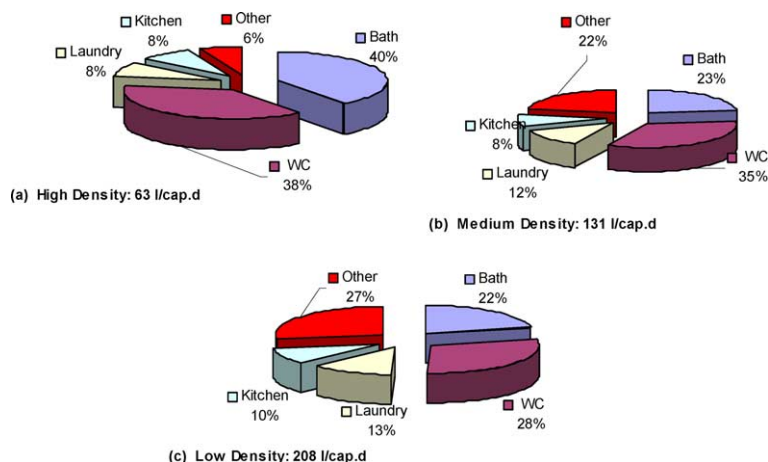

Fig. 6. Household wastewater sources for high, medium, and low density areas.

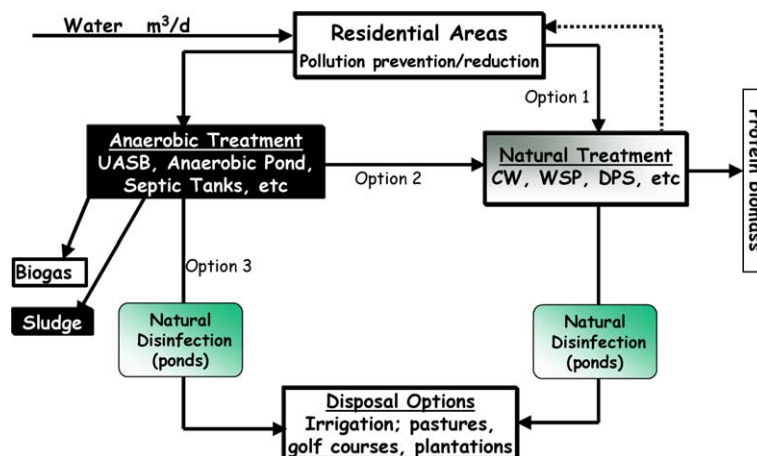

Fig. 7. Schematic presentation of an intermediate or decentralised system (CW = constructed wetlands; WSP = waste stabilisation ponds; DPS = duckweed-based pond systems).

Treatment can be via three options. The first one is for less concentrated wastewater and uses natural treatment methods like algae and duckweed-based ponds, and constructed wetlands, with harvesting of protein biomass. The dotted line indicates the return route of wastewater treatment plant effluent directly or indirectly to residential areas. The second is via anaerobic pretreatment to allow for effective organic matter stabilisation and subsequent recovery of biogas and reduced quantities of sludge. The water is then directed to natural treatment systems as for option 1. The third option is only different from the second one in that anaerobically treated effluent is reused after disinfection through maturation ponds. This route is not optimal but would suit small systems of about 10 households. Natural disinfection is by maturation ponds which are less expensive systems, and less preferably by other (expensive) methods like ozonation or UV radiation depending on effluent quality. The use of chlorine should be discouraged because of possible formation of trihalomethanes. In all

cases, the final effluent could be used for local urban agriculture, open space and pasture irrigation, or aquaculture. This whole set-up requires the uncoupling of industrial and similar effluents to avoid heavy metals and other toxic compounds as these affect treatment and sludge disposal, and sludge and water reuse.

## 6. Strategy implications

### 6.1. Water value

The wastewater produced per thousand people can potentially irrigate 2–6 ha per year of maize, the staple crop in Zimbabwe (Table 2). In other words, one person produces enough sewage to irrigate 210–380 m<sup>2</sup> depending on landuse category. If only greywater is used, then the area reduces to about 120–170 m<sup>2</sup>/person. This assessment shows that only greywater separation is feasible for high and medium density residential areas if all

Table 2  
Water and nutrient value of wastewater in Zimbabwe

Item	Unit	High density areas	Medium density areas	Low density areas
Wastewater production	l/cap d	63	131	208
Greywater production	l/cap d	35	61	91
N production	g/cap d	11	12	13
P production	g/cap d	1.2	1.3	1.4
Number of people per stand	people/stand	11	8	6
Area for cultivation based on Wastewater	m <sup>2</sup> /cap	211	319	380
Area for cultivation based on N, 3 crops/yr	m <sup>2</sup> /cap	841	667	542
Area for cultivation based on P, 3 crops/yr	m <sup>2</sup> /cap	535	422	341
Typical house area	m <sup>2</sup>	100	150	250
+20% of house area for other uses besides gardening	m <sup>2</sup>	20	30	50
<i>Comparison of area requirements</i>				
Water; total sewage	m <sup>2</sup>	331	499	680
Water, greywater only	m <sup>2</sup>	237	328	466
Nitrogen	m <sup>2</sup>	961	847	842
Phosphorus	m <sup>2</sup>	655	602	641
Average	m <sup>2</sup>	546	569	657

Note: Amounts required for cultivating 1 ha of maize: water 12,000 m<sup>3</sup>/ha, 175 kg N/ha, and 30 kg P/ha.

wastewater is to be reused within the stand boundary. However, for low-density areas, combined and greywater separation is feasible. The greywater separation option is even more attractive in terms of water savings; amounting to 47% for high density, 33% for medium density, and only 22% for low density water consumption. The low figure for low density areas is attributed to high water demand for gardening. Greywater separation will reduce water flows in sewers and the design flow will need to be adjusted to about 310 l/stand d for high density, 560 l/stand d for medium, and 700 l/stand d for low density residential areas. Such flows appear reasonable when compared to those in Bulawayo where reduction measures are in force (BCC, 2002).

### 6.2. Nutrient value

The distribution of nutrients in wastewater is such that it should never be wasted, as it is a valuable fertilizer resource. Each person produces about 8–14 g N/d and 1–3 g P/d (Metcalf and Eddy, 1991; JICA, 1996; Lindstrom, 1998). On the other hand, the application of 175 kg/ha N and 30 kg/ha P as artificial fertiliser produces 7 000 kg/ha maize grain in Zimbabwe (Veeberk, personal communications). This translates to a potential maize irrigation area of 5–9 ha per thousand people (Table 2). With proper planning, this area could be provided for this purpose in new urban developments. The fertiliser application rates given in literature are 200 kg/ha for nitrogen and 50–80 kg/ha for phosphorous to give a maize yield of 4000 kg/ha (Doorembos et al., 1979; ILACO B.V., 1981). These are higher than the local figures. Table 2 shows that far too much nitrogen and phosphorus quantities are produced for high and medium density stands

than can be utilised within the stand boundary. To avoid wastage and possible damage to crops, some of the nutrients will have to be exported from the stands. There is no problem with onsite disposal for low density stands. It is therefore concluded that onsite treatment and reuse of sewage for high and medium density stands in Zimbabwe will not be feasible from a nutrient and water utilisation point of view. These areas could be considered for decentralised systems.

### 6.3. Greywater separation

A greywater reuse strategy appears very favourable in Zimbabwe as greywater constitutes 56%, 46%, and 44%, respectively, of high, medium, and low-density household wastewater, respectively (Fig. 6). An assessment of greywater reuse potential was only done for residential areas. There are no published figures on greywater quality in Zimbabwe. However, literature shows that greywater contains about 10% of TN and 50–70% of TP of the household wastewater (Larsen and Guyer, 1996; Hanæus et al., 1997). These figures were adopted for assessment only as they are most likely to be different for Zimbabwe because of different diets and lifestyles. The results suggest that greywater separation will only account for all nitrogen but not phosphorus for high and medium density stands. This is because greywater contains the bulk of phosphorus in household wastewater. On the other hand, all nitrogen in greywater could be absorbed within the stands for all housing categories. Phosphorus is relatively immobile, so greywater could be safely adopted for all housing categories but this will result in wastage of resources unless higher phosphorus-uptake plants (e.g., maize) are used.

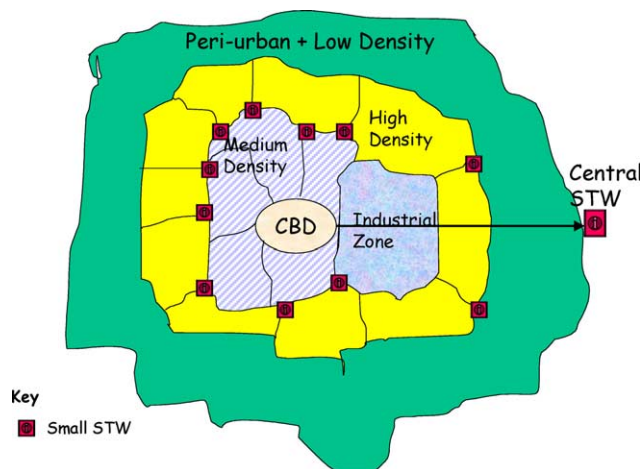

Fig. 8. A conceptual plan for decentralised treatment of wastewater.

#### 6.4. Integrated scheme

Fig. 8 shows how cities could be organised to incorporate onsite, decentralised, and centralised treatment of wastewater. Domestic effluents would be separated from industrial and commercial effluents. Domestic effluent would be treated in decentralised plants, closer to sources of generation, whilst industrial and commercial effluents would be treated at central level or separately. Effluent from low-density residential areas would be treated onsite. At all levels, wastewater reduction measures should be implemented and, depending on stand size, greywater reused.

#### 7. Conclusions

Although the decentralised concept of wastewater management is relatively new, there are practical examples in Zimbabwe that could be upgraded to meet this strategy. These are found in Gweru, Redcliff, Mupandawana and Nemanwa, and other towns. The decentralised strategy should utilise simple natural treatment methods for cost and sustainability reasons, and resource recovery should be the central theme. Consideration of water and nutrient value of sewage shows onsite treatment and reuse of sewage for high and medium density residential stands in Zimbabwe will not be feasible. These should be targeted for decentralised treatment. Greywater separation could be applied for all housing categories if high phosphorus-uptake plants are used.

#### Acknowledgments

The author is very grateful to councils who provided their precious time for discussions on this topic. Fund-

ing from the Netherlands Government, through the Sail Project is gratefully acknowledged.

#### References

- Asano, T., Levine, A.D., 1996. Wastewater reclamation, recycling and reuse: past, present and future. *IAWQ Water Sci.: Technol.* 33 (10–11), 1–14.
- Bowyer-Bower, T.A.S., Mapure, I., Drummond, R.B., 1996. Ecological degradation of cities: impact of urban agriculture in Harare, Zimbabwe. *J. Appl. Sci. Southern Africa (JSSA)* 2 (2), 53–67.
- Broome, J.M., Morris, P.M., Nanthambwe, J., 2002. Hybrid Treatment Systems—Anaerobic Ponds and Trickling Filters in Zimbabwe. In: *Proceedings of the 5th IWA Specialist Conference on Waste Stabilisation Ponds held in Auckland, New Zealand, April 2–5, 2002*, pp. 477–484.
- Cairncross, S., Feachem, R.G., 1983. *Environmental Health Engineering in Tropics—An Introductory Text*. John Wiley and Sons, Chichester, UK.
- Doorembos, J., Kassam, A.H., Bentvelsen, C.I.M., Branscherd, V., 1979. *Yield Response to Water Food and Agriculture Organisation*, Rome, Italy.
- Hanæus, J., Hellström, D., Johansson, E., 1997. A study of a urine separation system in an ecological village in northern Sweden. *Water Sci. Technol.* 35 (9), 153–160.
- ILACO B.V., 1981. *Agricultural Compendium for Rural Development in the Tropics and Subtropics*. Elsevier Scientific Publishing Company, Amsterdam, The Netherlands.
- IWSD, 2000. *An Investigation into the Potential Use of Duckweed-based Waste Stabilisation Ponds for Wastewater treatment in Small Urban Areas of Zimbabwe*. Annual progress Report, IWSD, Harare, Zimbabwe.
- JICA Report, 1996. *The Study of Water Pollution Control in Upper Manyame River Basin in the Republic of Zimbabwe*. MLGRUD, Nippon Jogeduido Sekkei Co. Ltd., Nippon Koei Co. Ltd., September 1996.
- Khoury, N., Kalbermatten, J.M., Bartone, C.R., 1994. *Reuse of Wastewater in Agriculture: A Guide for Planners*. UNB/WB Water and Sanitation Program, Washington, USA.
- Kusina, J., Mutisi, C., Govere, W., Mhona, R., Murenga, K., Ndamba, J., Taylor, P., 1999. Evaluation of Duckweed (*Lemma minor*) as a feed ingredient in the finisher diets of broiler chickens. *JASSA* 5 (1), 25–33.
- Larsen, T.A., Guyer, W., 1996. Separate management of anthropogenic nutrient solutions (human urine). *IAWQ Water Sci. Technol.* 34, 87–94.
- Lindstrom, C.R., 1998. *Greywater*. Cambridge, Available from <<http://greywater.com>>.
- Manjonjo, M., 1999. *Land Disposal of Sludge and Pond Effluent on Crowborough Farm: Its Efficiency and Influence on Marimba River*. MSc WREM Thesis, University of Zimbabwe, Harare, Zimbabwe.
- Mara, D., 1996. *Low-Cost Urban Sanitation*. John Wiley and Sons Ltd, Chichester, UK.
- Metcalf, X., Eddy, X., 1991. *Wastewater Engineering: Treatment, Disposal & Reuse*. McGraw-Hill, Inc., Singapore.
- Marks, R.F., 1993. *Appropriate sanitation options for Southern Africa*. *IAWQ Water Sci. Technol.* 34 (1).
- Nhapi, I., Siebel, M., Gijzen, H.J., 2002a. Options for the Onsite Management of Wastewater in Harare Zimbabwe, paper prepared for the IWA 5th Specialised Conference on Small Water and Wastewater Treatment Systems, Istanbul, Turkey, 24–26 September, 2002.



- Nhapi, I., Hoko, Z., Siebel, M., Gijzen, H.J., 2002b. Assessment of major water and nutrient flows in the Chivero catchment area, Zimbabwe. *Phys. Chem. Earth* 27, 783–792.
- Nhapi, I., Hoko, Z., 2002. A Cleaner Production Approach to Urban Water Management: Potential for Application in Harare, Zimbabwe. In: *Proceedings of the 3rd Waternet/WARFSA Symposium in Dar Es Salaam, Tanzania, October 30–31, 2002*, pp. 573–583.
- Pescod, M.B., 1992. *Wastewater Treatment and Use in Agriculture*. FAO, Rome, Italy.
- Siebel, M.A., Gijzen, H.J., 2002. Application of Cleaner Production Concepts in Urban Water Management, paper presented at the Environmental Technology and Management Seminar 2002, Bandung, Indonesia, January 9–10, 2002.
- Taylor, P., Mudege, N.R., 1997. Urban Sanitation in Zimbabwe and the Relation to Environmental Pollution. Institute of Water and Sanitation Development, Harare, Zimbabwe.
- Venhuizen, D., 1998. The Decentralised Concept of Wastewater Management, Available from <[http://www.geocities.com/RainForest/Vines/5240/Venh\\_ww.html](http://www.geocities.com/RainForest/Vines/5240/Venh_ww.html)>.